

Fili disponibili dal: 1.4

				DATA	27/05/2005			SEGRITRICE A NASTRO	R_01_05		
				DISEG.	IMR			ALIMENTAZIONE GENERALE	R_01_05		
				VISTO					R_01_05.DWG		FOGLIO 1 DI 19
REV.	MODIFICA	DATA	FIRMA	APPR.	SOST. IL:	SOST. DA:	ORIGINE:			SEGUE 2	
1		2			3	4	5	6	7	8	

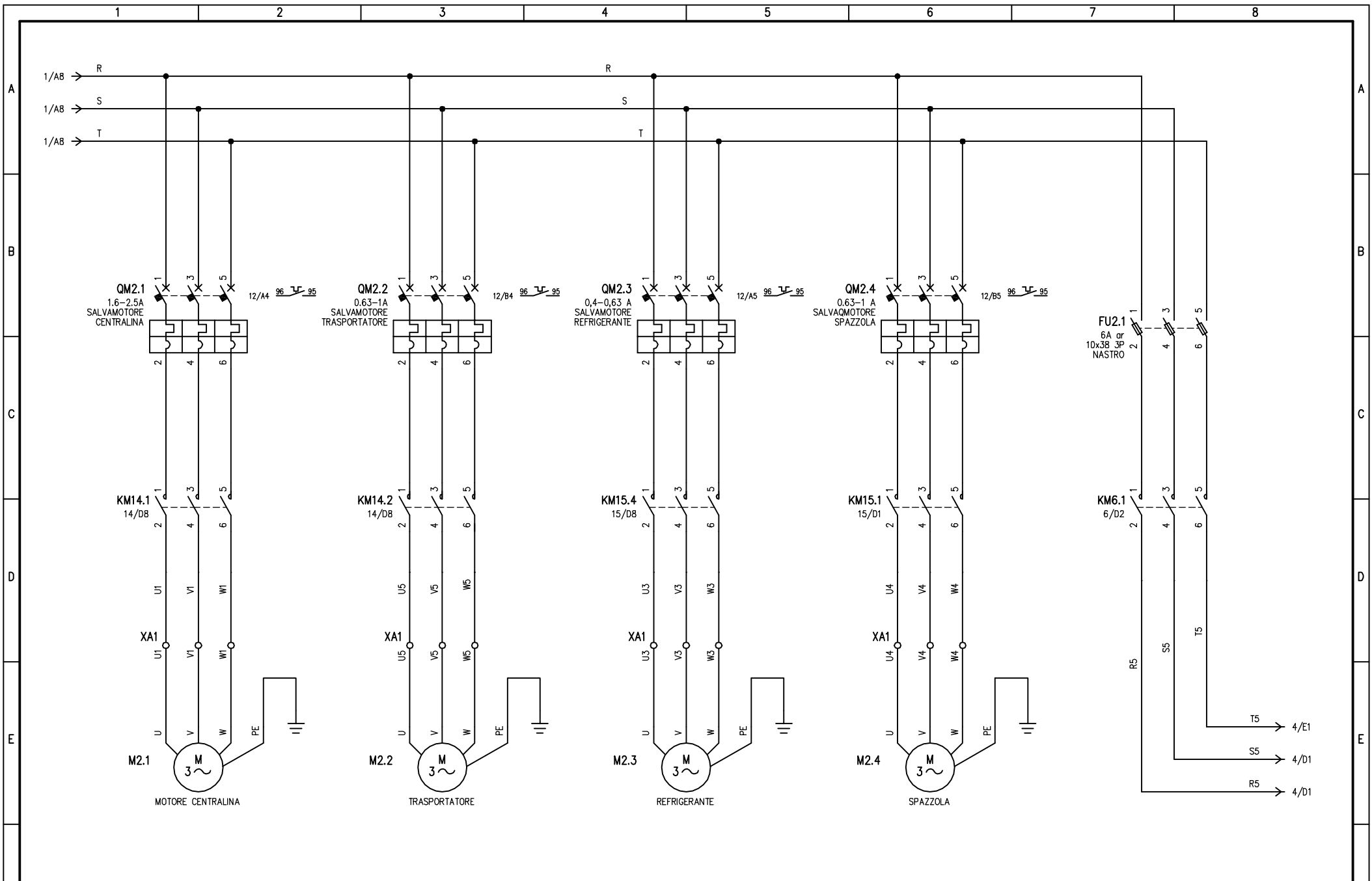

Fili disponibili dat: 2.1

				DATA	27/05/2005			SEGATRICE A NASTRO		R_01_05			
				DISEG.	IMR			POTENZA MOTORI SEGATRICE		R_01_05			
				VISTO						R_01_05.DWG		FOGLIO 2 DI 19	
REV.	MODIFICA	DATA	FIRMA	APPR.	SOST. IL:	SOST. DA:	ORIGINE:					SEGUE 3	
1		2		3	4	5	6	7	8				

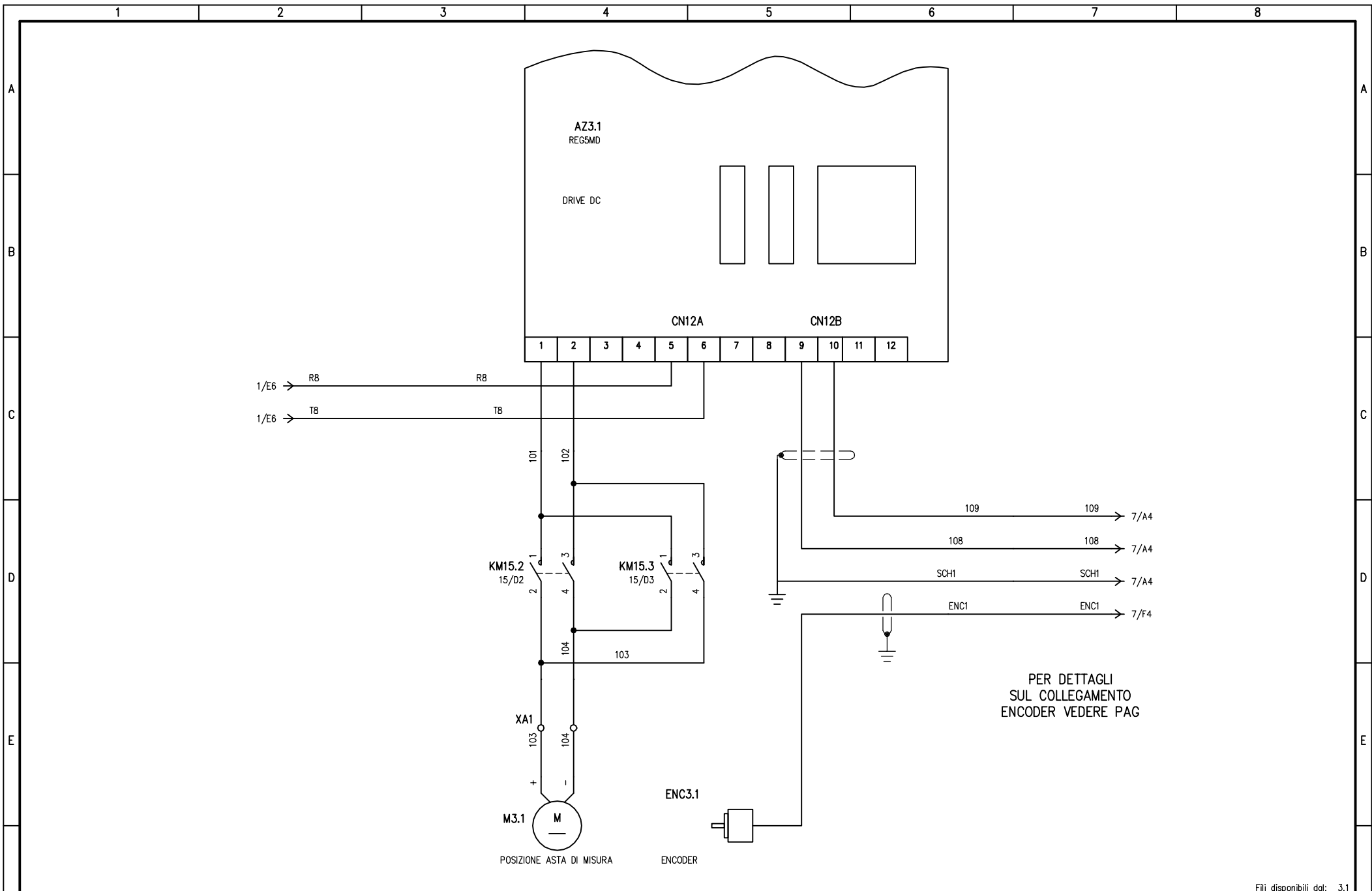

Fili disponibili dal: 3.1

				DATA	27/05/2005			SEGATRICE A NASTRO	R_01_05				
				DISEG.	IMR			AZIONAMENTO ASTA DI MISURA					
				VISTO					R_01_05			FOGLIO	3 DI 19
REV.	MODIFICA	DATA	FIRMA	APPR.	SOST. IL:	SOST. DA:	ORIGINE:			R_01_05.DWG		SEGUE	4
1		2			3	4	5	6	7	8			

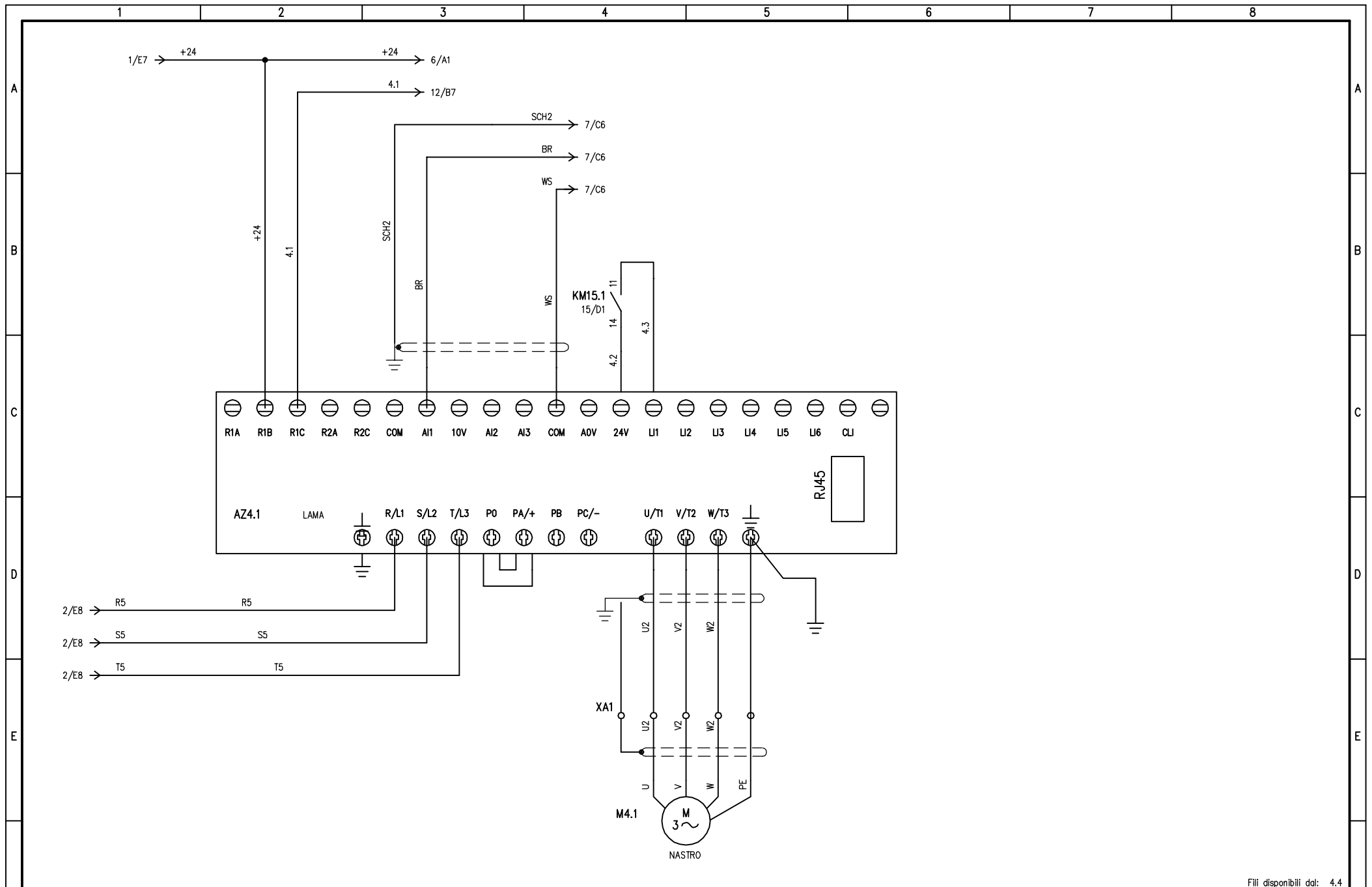

Fili disponibili dal: 4.4

1		20/10/2004		DATA	27/05/2005			SEGATRICE A NASTRO	R_01_05		
				DISEG.	MR			INVERTER MOTORE NASTRO			
				VISTO				TELEMECANIQUE	R_01_05		
REV.	MODIFICA	DATA	FIRMA	APPR.		SOST. IL:	SOST. DA:	ORIGINE:		R_01_05.DWG	FOGLIO 4 DI 19
											SEGUE 4A

B7

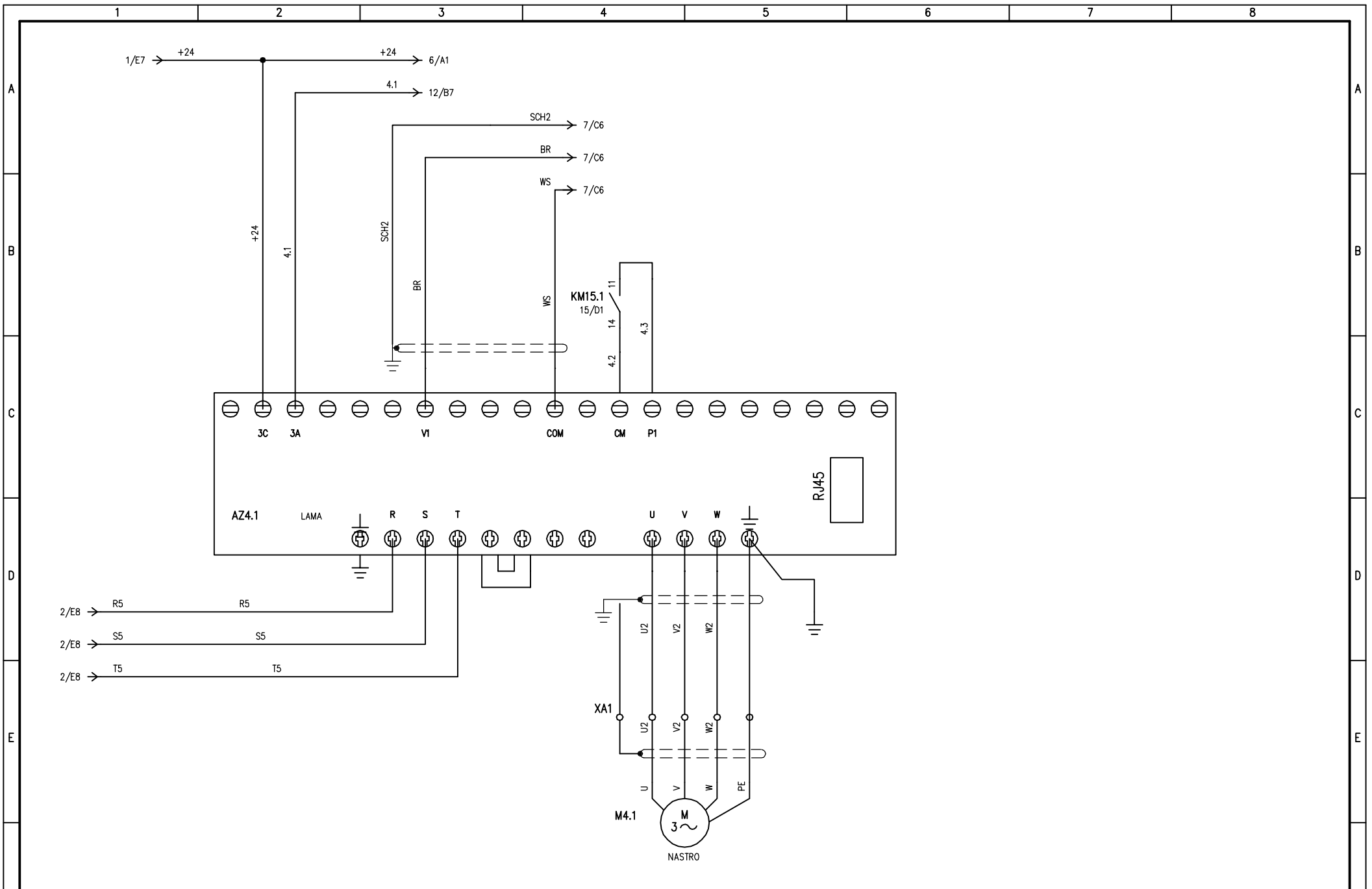

				DATA	27/05/2005			SEGRITRICE A NASTRO	R_01_05		
				DISEG.	IMR			INVERTER MOTORE NASTRO			
				VISTO				LG	R_01_05	R_01_05.DWG	FOGLIO 4A DI 19
REV.	MODIFICA	DATA	FIRMA	APPR.	SOST. IL:	SOST. DA:	ORIGINE:				SEGUE 5
1		2		3		4		5	6	7	8

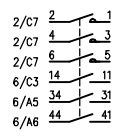
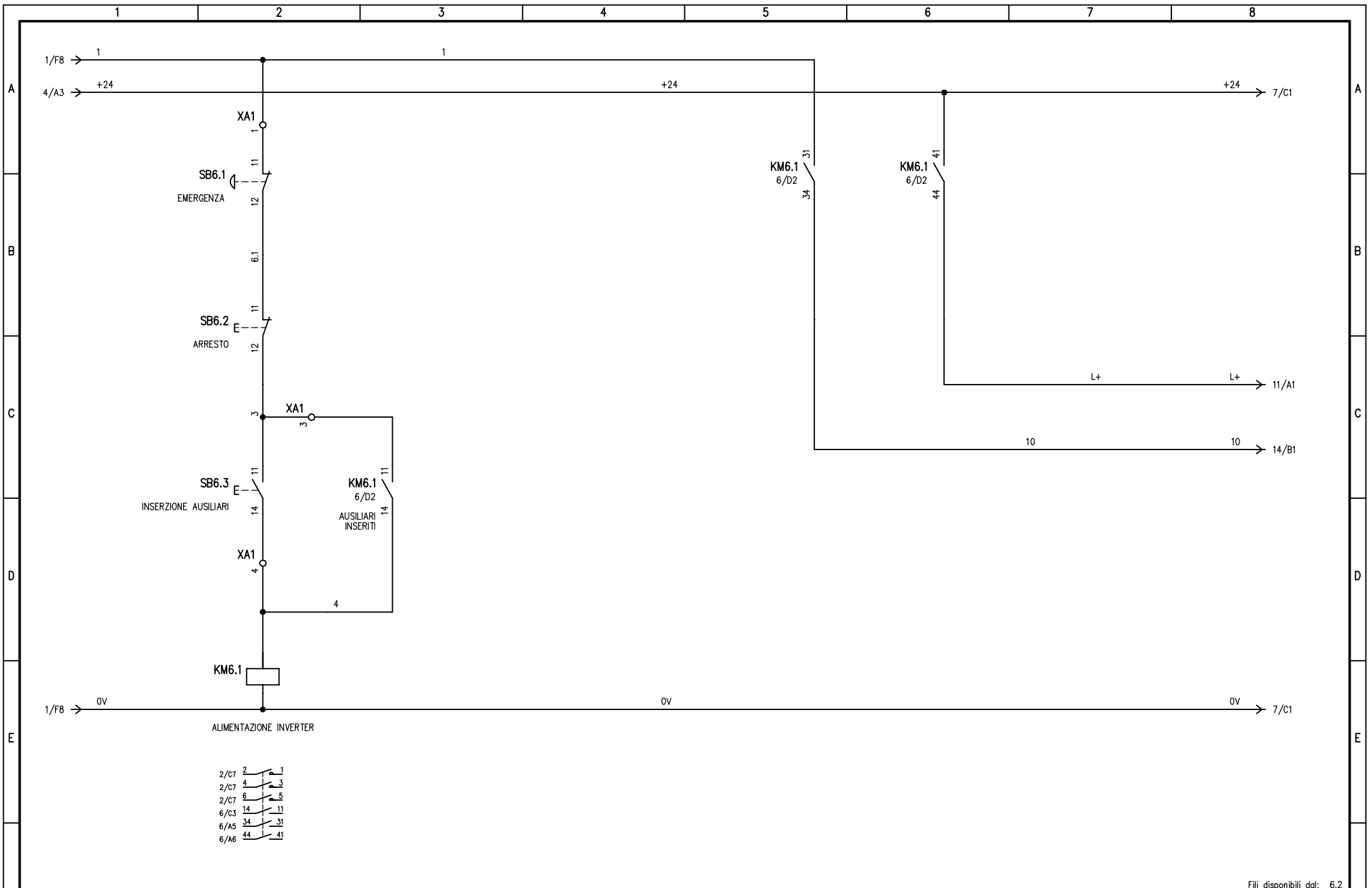

Fili disponibili dal: 6.2

				DATA	27/05/2005			SEGATRICE A NASTRO	R_01_05		
				DISEG.	IMR			CIRCUITO EMERGENZA			
				VISTO					R_01_05		
REV.	MODIFICA	DATA	FIRMA	APPR.	SOST. IL:	SOST. DA:	ORIGINE:	R_01_05.DWG		FOGLIO	6 DI 19
1		2			3	4	5	6	7	8	7
										SEQUE	7

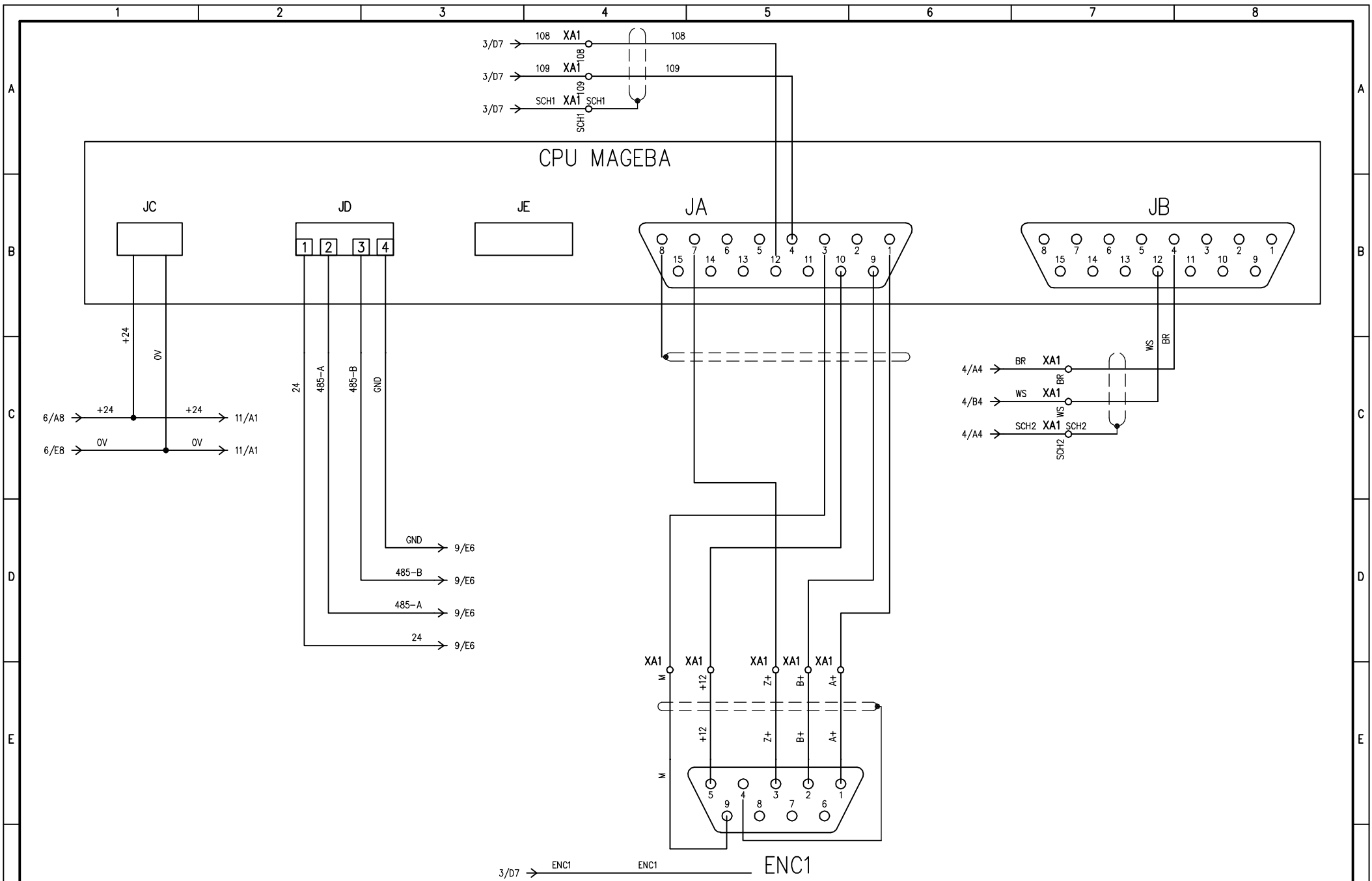

				DATA	27/05/2005			SEGATRICE A NASTRO	R_01_05			F
				DISEG.	IMR			COMPOSIZIONE CPU	R_01_05			
				VISTO					R_01_05	R_01_05.DWG		FOGLIO 7 DI 19
REV.	MODIFICA	DATA	FIRMA	APPR.	SOST. IL:	SOST. DA:	ORIGINE:					SEGUE 8
1		2			3	4	5	6	7	8		

Fili disponibili dal: 7.1

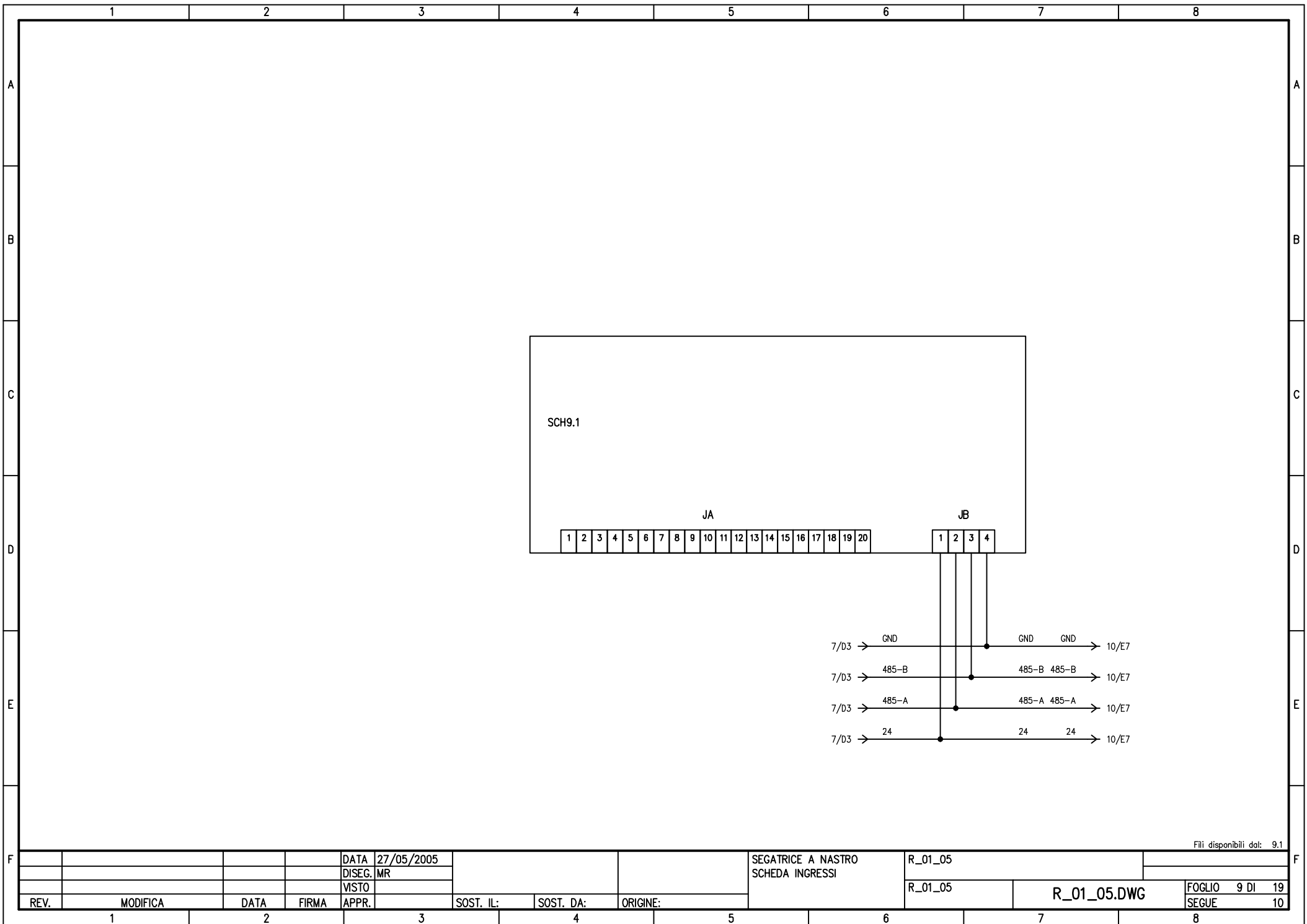

Fili disponibili dal: 9.1

DATA	27/05/2005				SEGRITRICE A NASTRO	R_01_05		
DISEG.	IMR				SCHEDA INGRESSI	R_01_05		
VISTO						R_01_05	R_01_05.DWG	FOGLIO 9 DI 19
REV.	MODIFICA	DATA	FIRMA	APPR.	SOST. IL:	SOST. DA:	ORIGINE:	SEGUE 10

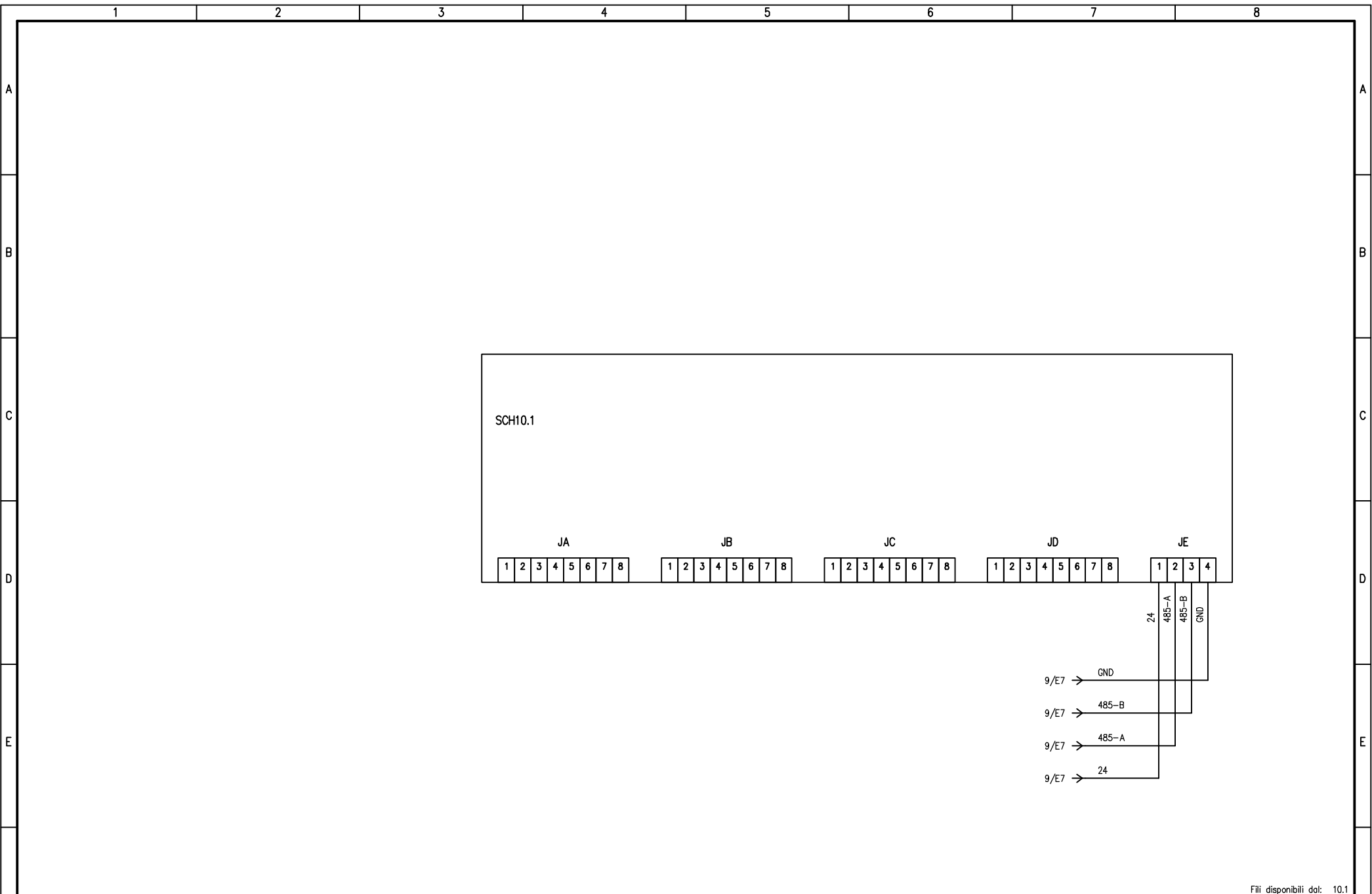

Fili disponibili dal: 10.1

DATA	27/05/2005			SEGATRICE A NASTRO	R_01_05		
DISEG.	MR			SCHEDA USCITE	R_01_05		
VISTO					R_01_05	R_01_05.DWG	FOGLIO 10 DI 19
REV.	MODIFICA	DATA	FIRMA	APPR.	SOST. IL:	SOST. DA:	ORIGINE:

SECUE 11

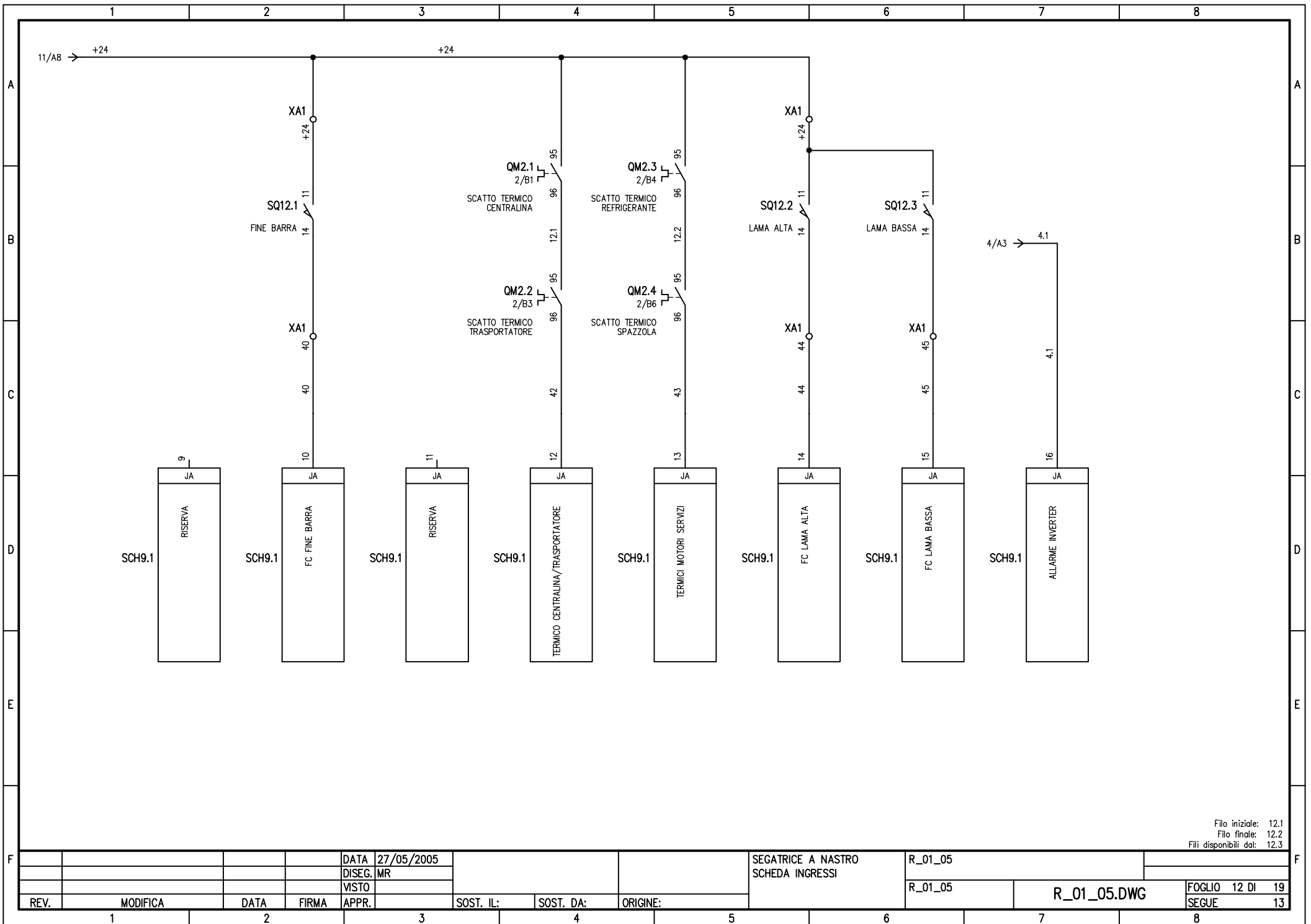

Filo iniziale: 12.1
 Filo finale: 12.2
 Filii disponibili dal: 12.3

				DATA	27/05/2005				SEGATRICE A NASTRO	R_01_05			
				DISEG.	IMR				SCHEDA INGRESSI	R_01_05			
				VISTO							FOGLIO 12 DI 19		
REV.	MODIFICA	DATA	FIRMA	APPR.	SOST. IL:	SOST. DA:	ORIGINE:			R_01_05.DWG		SEGUE	13
1		2		3		4		5		6	7	8	

	1	2	3	4	5	6	7	8	
A									
B									
C									
D	SCH9.1	SCH9.1	SCH9.1	SCH9.1					
E									
F				DATA 27/05/2005			SEGRITRICE A NASTRO SCHEDA INGRESSI	R_01_05	
				DISEG. IMR			R_01_05	R_01_05.DWG	FOGLIO 13 DI 19
	REV.	MODIFICA	DATA	FIRMA	APPR.	SOST. IL:	SOST. DA:	ORIGINE:	SEGUE 14
	1	2	3	4	5	6	7	8	

SCH9.1

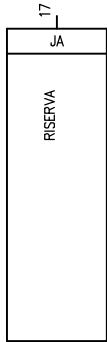

SCH9.1

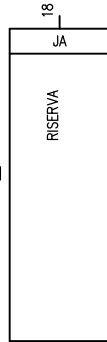

SCH9.1

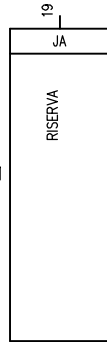

SCH9.1

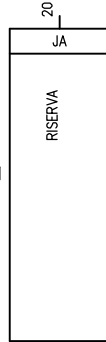

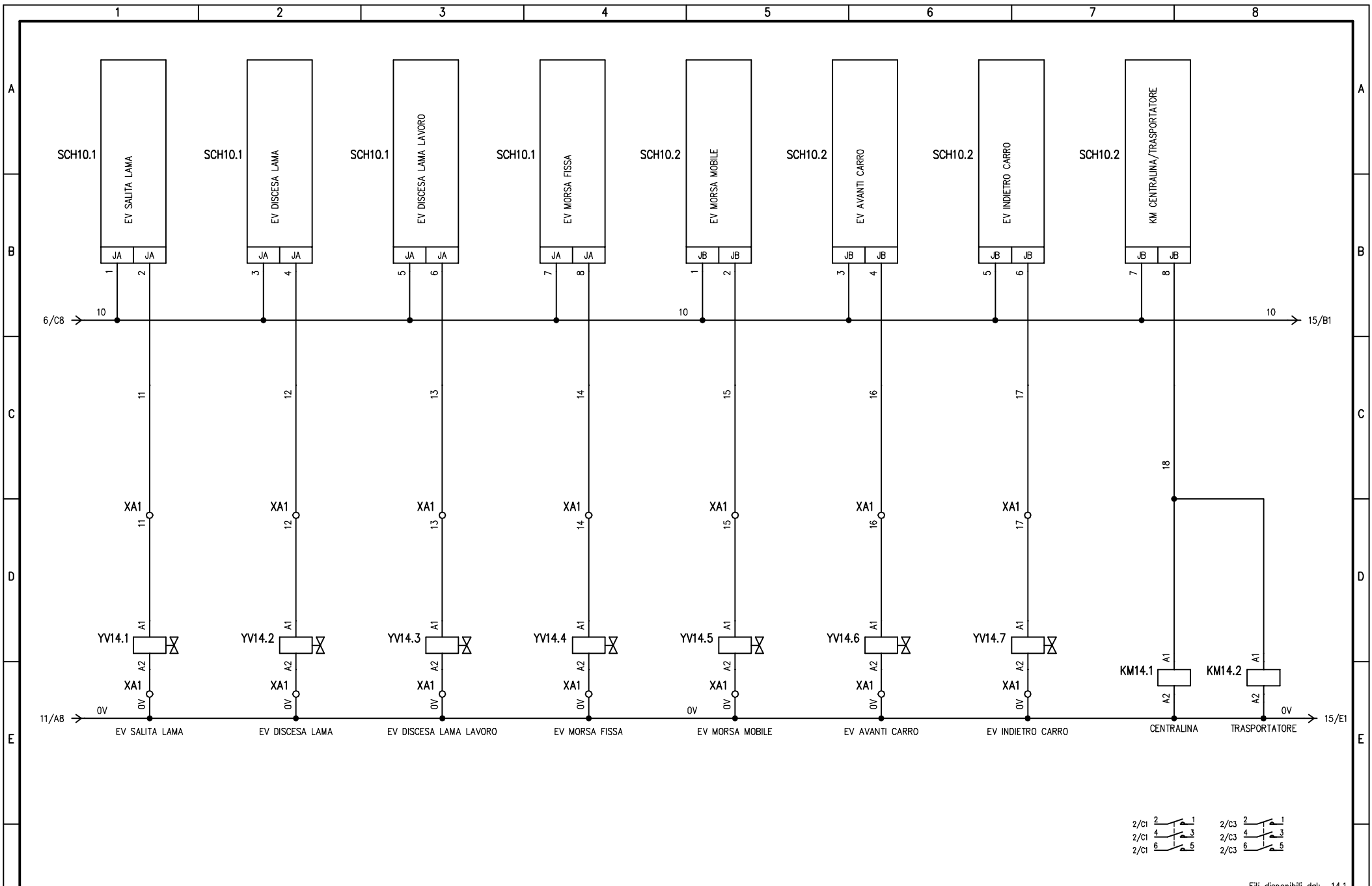

Fili disponibili dal: 14.1

				DATA	27/05/2005				SEGRITRICE A NASTRO		R_01_05			
				DISEG.	IMR				SCHEDA USCITE		R_01_05			
				VISTO							R_01_05.DWG		FOGLIO 14 DI 19	
REV.	MODIFICA	DATA	FIRMA	APPR.	SOST. IL:	SOST. DA:	ORIGINE:					SEGUE 15		
1		2			3	4	5	6	7	8				

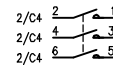
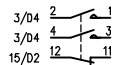
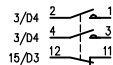
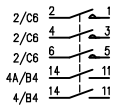
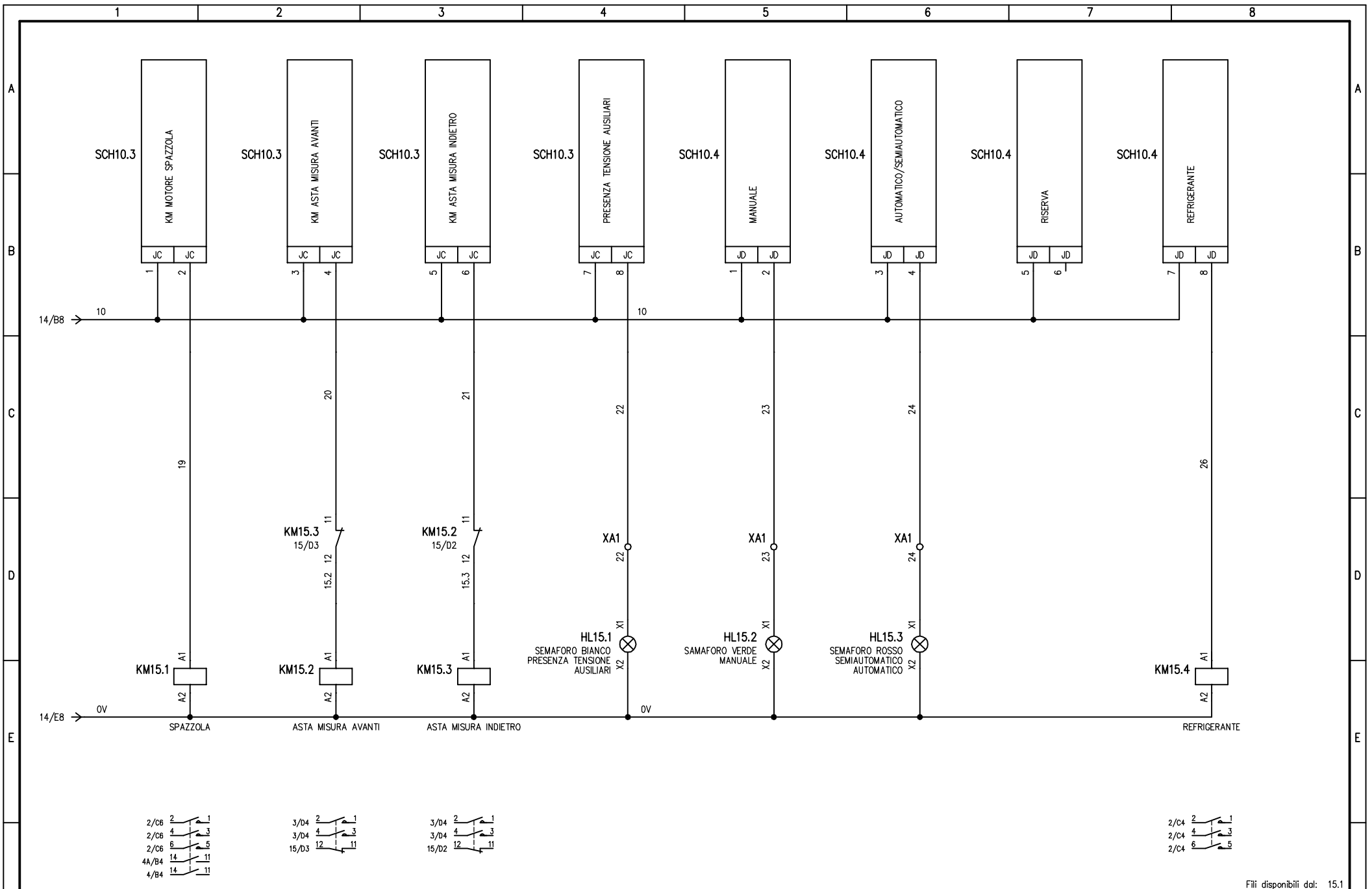

Fili disponibili dal: 15.1

				DATA	27/05/2005			SEGATRICE A NASTRO		R_01_05			
				DISEG.	IMR			SCHEDA USCITE					
				VISTO						R_01_05			
REV.	MODIFICA	DATA	FIRMA	APPR.	SOST. IL:	SOST. DA:	ORIGINE:			R_01_05.DWG		FOGLIO	15 DI 19
1		2		3			5					SEGUE	16

1

2

3

4

5

6

7

8

A

A

B

B

C

C

D

D

E

E

F

F

				DATA	27/05/2005				SEGATRICE A NASTRO	R_01_05		
				DISEG.	MR				RISERVA			
				VISTO						R_01_05		
REV.	MODIFICA	DATA	FIRMA	APPR.	SOST. IL:	SOST. DA:	ORIGINE:				R_01_05.DWG	FOGLIO 16 DI 19
1		2			3	4	5	6	7	8		SEGUE 17

1

2

3

4

5

6

7

8

A

A

B

B

C

C

D

D

E

E

F

F

				DATA	27/05/2005				SEGATRICE A NASTRO	R_01_05		
				DISEG.	IMR				RISERVA			
				VISTO						R_01_05		
REV.	MODIFICA	DATA	FIRMA	APPR.	SOST. IL:	SOST. DA:	ORIGINE:				R_01_05.DWG	FOGLIO 17 DI 19 SEGUE

1

2

3

4

5

6

7

8